

Wrist Digital Blood Pressure Monitor

Model UB-542



Instruction Manual
Original

Manuel d'instructions

Manual de Instrucciones

Manuale di Istruzioni

使用手冊

Contents

Dear Customers	2
Preliminary Remarks	2
Precautions	2
Parts Identification	3
Symbols	4
Using the Monitor	6
1. Installing / Changing the Batteries	6
2. Adjusting the Built-in Clock	7
3. Applying the Cuff	8
4. How to Take Proper Measurements	8
5. Measurement	8
6. After Measurement	8
Measurements	9
Notes For Accurate Measurement	10
Deleting all Data Stored in Memory	10
Recalling the Memory Data	11
What is an Irregular Heartbeat?	12
Pressure Bar Indicator	12
WHO Classification Indicator	13
About Blood Pressure	13
What is Blood Pressure?	13
What is Hypertension and How is it Controlled?	13
Why Measure Blood Pressure at Home?	14
WHO Blood Pressure Classification	14
Blood Pressure Variations	14
Troubleshooting	15
Maintenance	16
Technical Data	16

Dear Customers

Congratulations on purchasing a state-of-the-art A&D blood pressure monitor, one of the most advanced monitors available today. Designed for ease of use and accuracy, this monitor will facilitate your daily blood pressure regimen.  **We recommend that you read through this manual carefully before using the device for the first time.**

Preliminary Remarks

- This device conforms to the European Directive 93/42 EEC for Medical Products. This is made evident by the **CE**₀₃₆₆ mark of conformity. (0366: The reference number to the involved notified body)
- The device is designed for use on adults only, not newborns or infants.
- Environment for use
The device is for use indoors.

Precautions





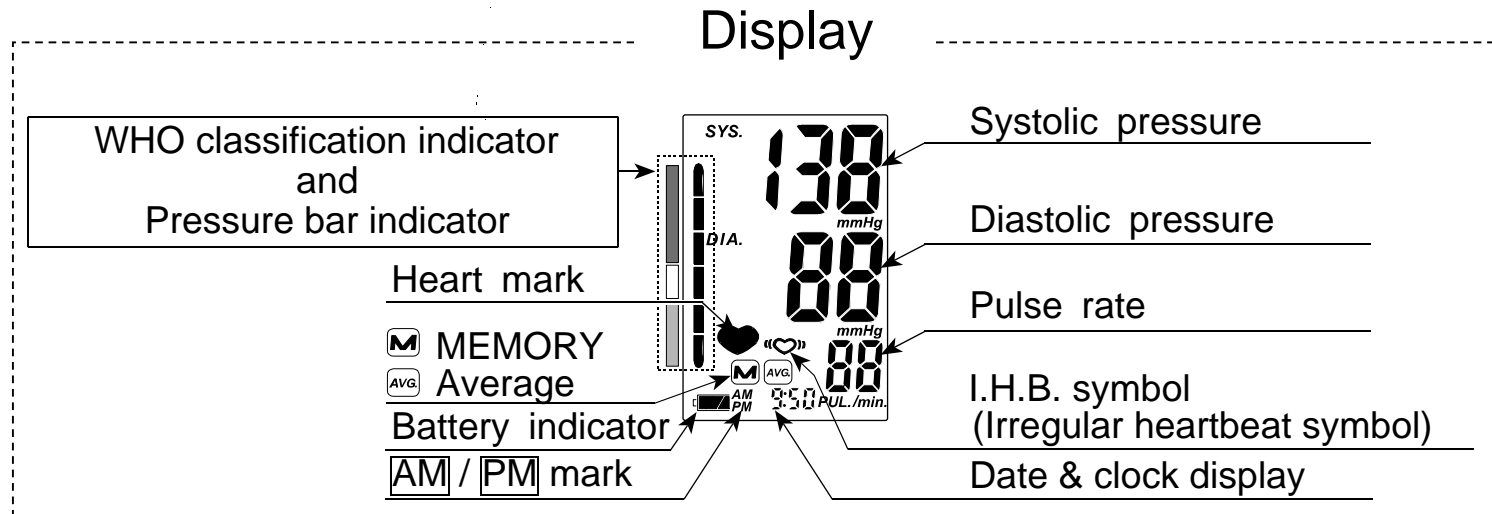
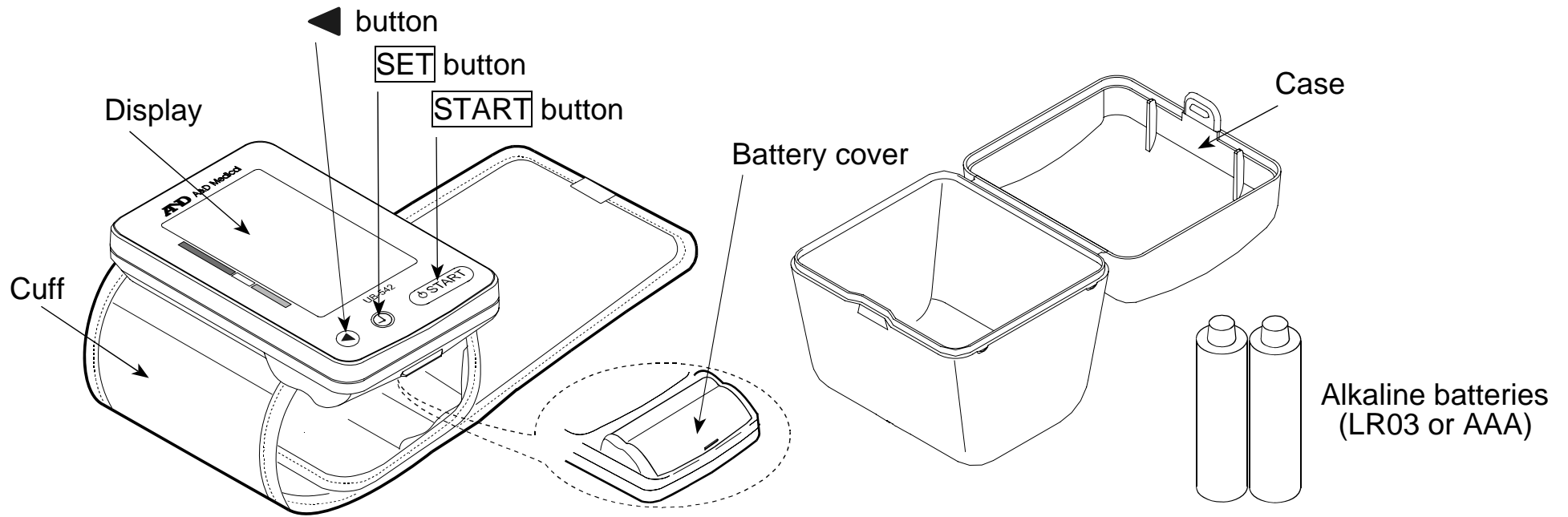

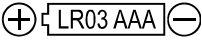

- Precision components are used in the construction of this device. Extremes in temperature, humidity, direct sunlight, shock or dust should be avoided.
- Clean the device and cuff with a dry, soft cloth or a cloth dampened with water and a neutral detergent. Never use alcohol, benzene, thinner or other harsh chemicals to clean the device or cuff.
- Avoid tightly folding the cuff for long periods, as such treatment may shorten the life of the components.
- The device and cuff are not water resistant. Prevent rain, sweat and water from soiling the device and cuff.
- Measurements may be distorted if the device is used close to televisions, microwave ovens, cellular telephones, X-ray or other devices with strong electrical fields.
- Used equipment, parts and batteries are not treated as ordinary household waste, and must be disposed of according to the applicable local regulations.
- When your wrist is squeezed tightly by a cuff, blood collects in the finger tips and your wrist may become congested.

Parts Identification





Symbols

Symbols that are printed on the device case





Symbols	Function / Meaning	Recommended Action
	Standby and Turn the device on	_____
	Battery installation guide	_____
	Direct current	_____
SN	Serial number	_____
2012 	Date of manufacture	_____
	Type BF: Device and cuff are designed to provide special protection against electrical shocks.	_____
 0366	EC directive medical device label	_____
	WEEE label	_____
	Manufacturer	_____
	EU-representative	_____
	Consult instructions for use	_____

Symbols that appear on the display

Symbols	Function / Meaning	Recommended Action
	Appears while measurement is in progress. It blinks when the pulse is detected.	Measurement is in progress. Remain as still as possible.
	Irregular Heartbeat symbol (I.H.B.) Appears when an irregular heartbeat is detected. It may light when a very slight vibration like shivering or shaking is detected.	_____

Symbols

Symbols that appear on the display (continued)

Symbols	Function / Meaning	Recommended Action
	Previous measurements stored in MEMORY.	_____
	Average data	_____
 Full Battery	The battery power indicator during measurement.	_____
 Low Battery	The battery is low when it blinks.	Replace all batteries with new ones when the indicator blinks.
E_1 or E_2	Unstable blood pressure due to movement during measurement. The systolic and diastolic values are within 10 mmHg of each other.	Take another measurement. Remain still during measurement.
E_3	The pressure value did not increase during inflation. The cuff is not applied correctly.	Apply the cuff correctly, and take another measurement.
E PUL. DISPLAY ERROR	The pulse is not detected correctly	
E_4 E_5 E_6 E_7 E_8 E_9	Blood pressure monitor internal error	
SYS.	Systolic blood pressure in mmHg	_____
DIA.	Diastolic blood pressure in mmHg.	_____
PUL./min.	Pulse per minute	_____
AM	Data taken between 4:00 and 9:59	_____
PM	Data taken between 18:00 and 1:59	_____



Using the Monitor

1. Installing / Changing the Batteries

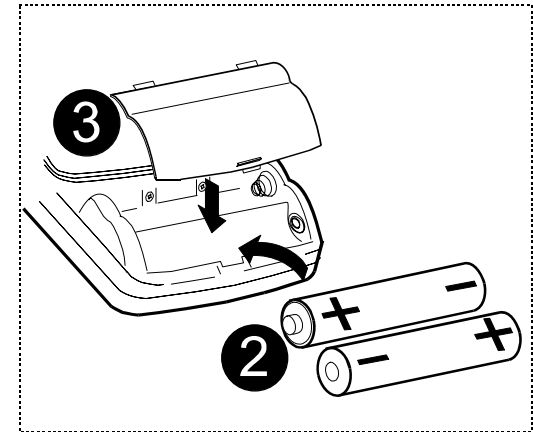
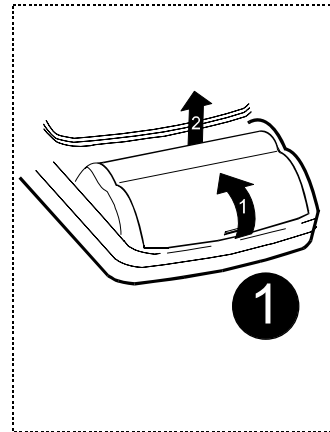
1. Remove the battery cover.
2. Remove the used batteries and insert new batteries into the battery compartment as shown, taking care that the polarities (+ and -) are correct. Use only LR03 or AAA batteries.
3. Attach the battery cover.



⚠ CAUTION

- Insert the batteries as shown in the battery compartment. If installed incorrectly, the device will not work.
- When  (LOW BATTERY mark) appears on the display, replace all batteries with new ones. Do not mix old and new batteries. It may shorten the battery life, or cause the device to malfunction.
-  (LOW BATTERY mark) does not appear when the batteries are drained.
- The battery life varies with the ambient temperature and may be shorter at low temperatures.
- Use the specified batteries only. The batteries provided with the device are for testing monitor performance and may have a limited life.
- Remove the batteries if the device is not to be used for a long period of time. The batteries may leak and cause a malfunction.

Using the Monitor

2. Adjusting the Built-in Clock

Adjust the clock prior to use.

1. Press the **SET** button until the year starts blinking.
2. Select the year using the ◀ button.

Press the **SET** button to set the current year and move to month/day selection.
The date can be set anywhere between the years 2011 and 2059.

3. Select the month using the ◀ button.
Press the **SET** button to set the current month and move to day selection.
4. Select the day using the ◀ button.
Press the **SET** button to set the current day and move to hour/minute selection.
5. Select the hour using the ◀ button.
Press the **SET** button to set the current hour and move to minute selection.
6. Select the minute using the ◀ button.
Press the **SET** button to turn the device off.

- Holding down the ◀ button will change the value continuously.
- Pressing the **START** button will turn the device off anytime.

Notes: After three minutes of non-operation, the device will turn off automatically.

When the clock has not been set, the clock display indicates dashes as shown to the right.

- - / - -

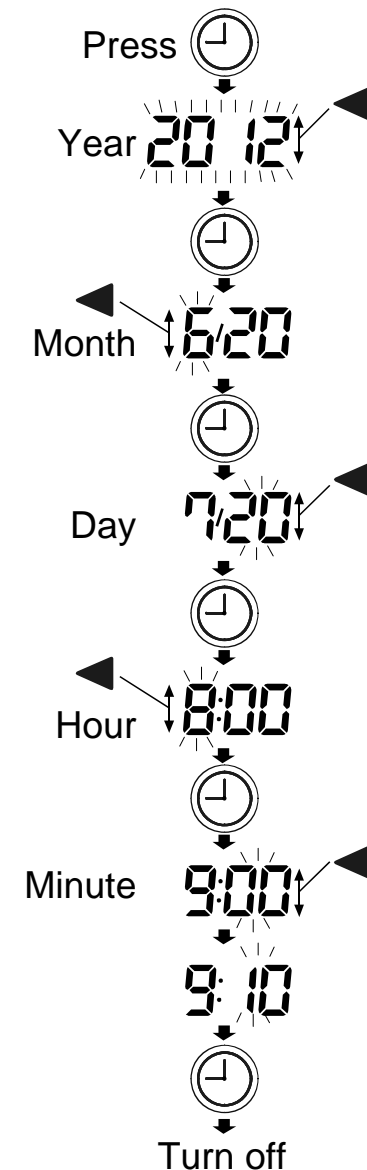

Using the Monitor

3. Applying the Cuff

1. Wrap the cuff around your wrist about 1 cm above your hand as shown in the figure at the right.
2. Fasten the cuff tightly using the Velcro strip.

Note: For proper measurements, fasten the cuff tightly and measure on a bare wrist.

4. How to Take Accurate Measurements

For the most accurate blood pressure measurement:

- Sit comfortably at a table. Rest your arm on the table.
- Relax for about five to ten minutes before measurement.
- Raise your hand so that the cuff is at the same level as your heart.
- Remain still and keep quiet during measurement.
- Do not measure immediately after physical exercise or a bath.
Rest for twenty or thirty minutes before taking the measurement.
- Try to measure your blood pressure at about the same time every day.

5. Measurement

During measurement, it is normal for the cuff to feel very tight. (Do not be alarmed.)

6. After Measurement

After measurement, press the **START** button to turn the device off. Remove the cuff and record your data.

Notes: The device is provided with an automatic power shut-off function which turns the device off automatically one minute after measurement.

Allow at least three minutes between measurements on the same person.

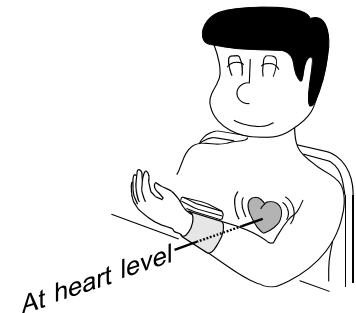
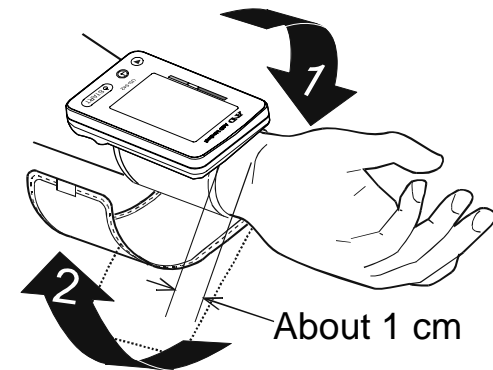

Measurements

Note: The UB-542, once used, will provide an inflation appropriate to the user, based on the previous measurement.

1. Sit comfortably with the cuff at the same level as your heart and relax.

2. Press the **START** button.

All of the display segments are displayed.
Zero (0) is displayed blinking briefly.

Then the display changes, as indicated in the figure at the right, as measurement begins.

The cuff starts to inflate. It is normal for the cuff to feel very tight.

Note: If you wish to stop inflation at any time, press the **START** button again.

3. The measurement starts automatically when inflation starts, and the ♥ (heart mark) blinks.

4. When the measurement is complete, the systolic and diastolic pressure readings and pulse rate are displayed.
During the data display, the date and time are displayed alternately.

The cuff exhausts the remaining air and completely deflates automatically.

5. Press the **START** button again to turn the device off.
Remove the cuff.

Notes: The device is provided with an automatic power shut-off function.

Allow at least three minutes between measurements on the same person.

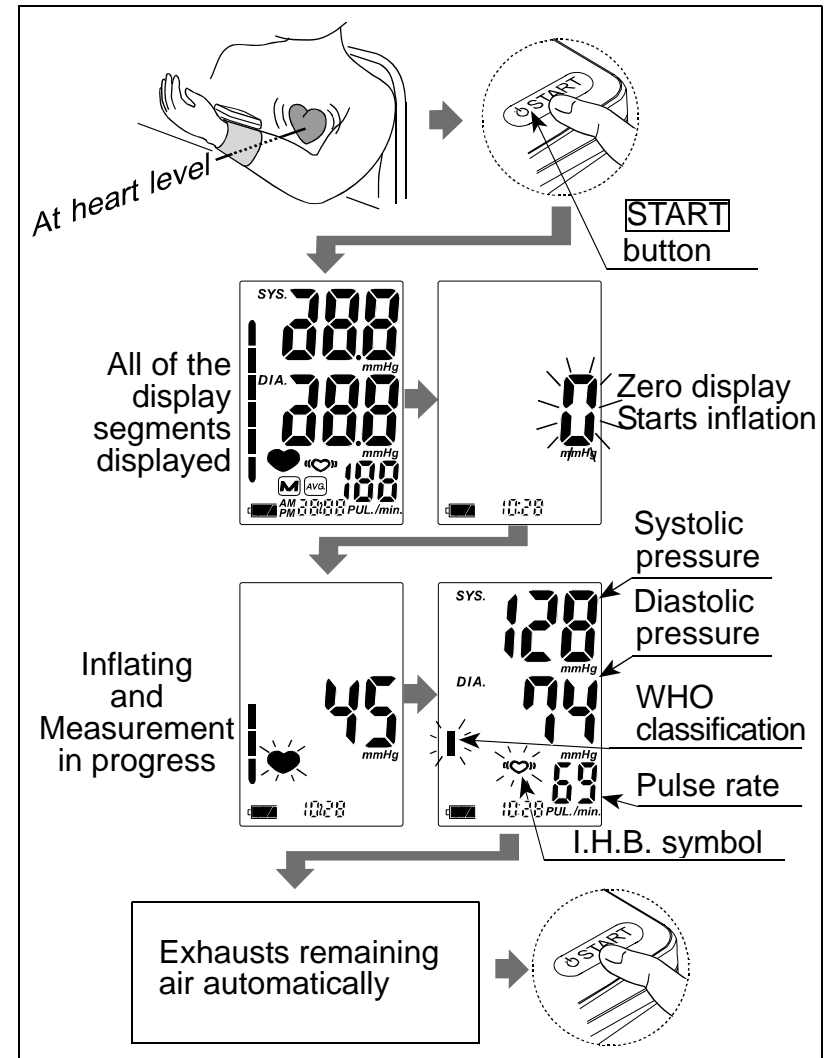

Measurements

Notes For Accurate Measurement

- ❑ Sit down in a comfortable position. Place your arm on a table or other support. Raise your hand so that the cuff is at the same level as your heart.
- ❑ Relax for about five to ten minutes before taking a measurement. If you are excited or depressed by emotional stress, the measurement will reflect this stress as a higher (or lower) than normal blood pressure reading and the pulse reading will usually be faster than normal.
- ❑ An individual's blood pressure varies constantly, depending on what they are doing and what they have eaten. What you drink can have a very strong and rapid effect on your blood pressure.
- ❑ This device bases its measurements on the heartbeat. If you have a very weak or irregular heartbeat, the device may have difficulty determining your blood pressure.
- ❑ Should the device detect a condition that is abnormal, it will stop the measurement and display an error symbol. See page 5 for the description of symbols.
- ❑ This blood pressure monitor is intended for use by adults only. Consult with your physician before using this device on a child. A child should not use this device unattended.

Deleting all Data Stored in Memory

When the display screen is blank, press and hold the ◀ button. The M mark appears. After a while it starts blinking, then disappears. Now all data stored in memory has been deleted.

Note: This operation will delete all data stored in memory. You cannot select which data to delete.

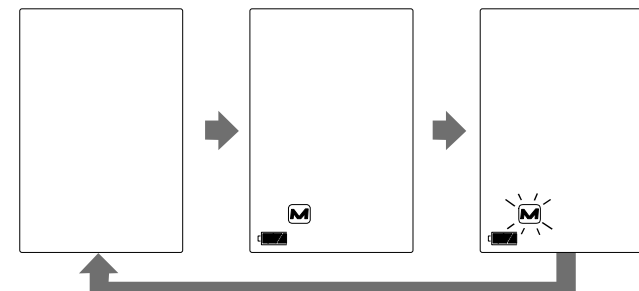

Recalling the Memory Data

Note: This device stores the last 90 measurements in memory.

- Press the ◀ button.
The average of all measurements and the number of data are displayed.
(If no data, "0" is displayed. Press the ◀ or **START** button to turn the device off.)
- Each time the ◀ button is pressed, the memory data is displayed as follows.
 - Average of all AM (morning) measurements taken between 4:00 and 9:59.
(In the example, 8 measurements. If no data, "--" is displayed.)
 - Average of all PM (evening) measurements taken between 18:00 and 1:59.
(In the example, 18 measurements. If no data, "--" is displayed.)
 - Most recent data (No.n, in the example, No.35)
 - Three seconds after the data number display, the measurement data is displayed.
During the data display, the date and time are displayed alternately.
 - ⋮
 - Last data (No.1)
 - Three seconds after the data number display, the measurement data is displayed.
- After the last data is displayed, press the ◀ button to return the average display of all measurements.
- Press the **START** button to turn the device off.
After one minute of non-operation, the device will turn off automatically.

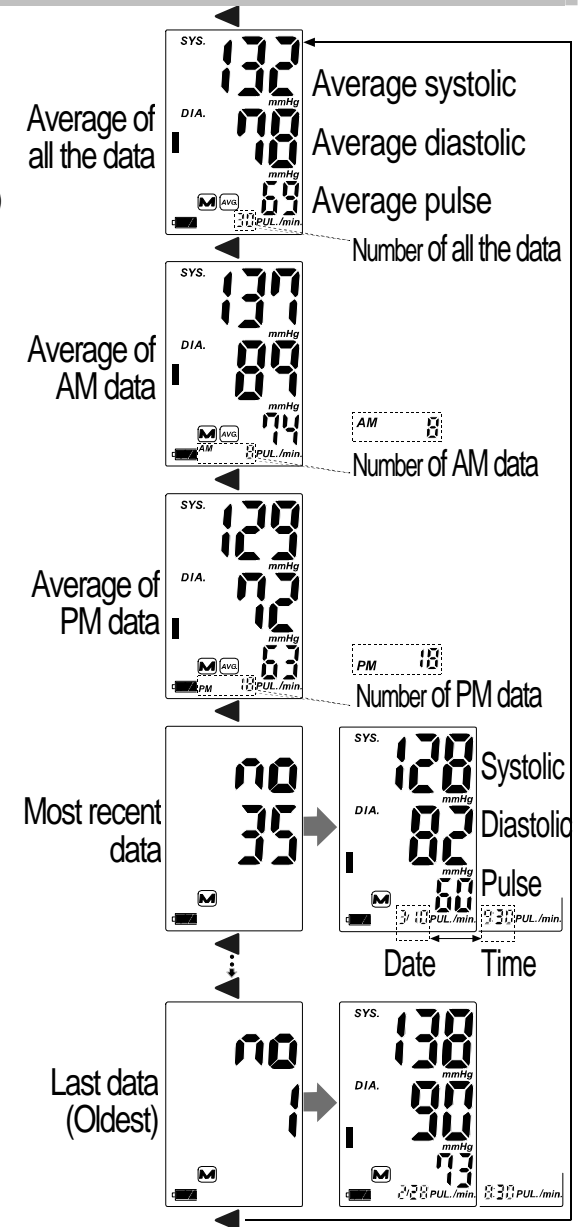

What is an Irregular Heartbeat?

Model UB-542 blood pressure monitor provides a blood pressure and pulse rate measurement even when an irregular heartbeat occurs. An irregular heartbeat is defined as a heartbeat that varies by 25% from the average of all heartbeats during the blood pressure measurement. It is important that you be relaxed, remain still and do not talk during measurements.

Note: We recommend contacting your physician if you see this «♥» symbol frequently.

Pressure Bar Indicator

The indicator monitors the progress of pressure during measurement.

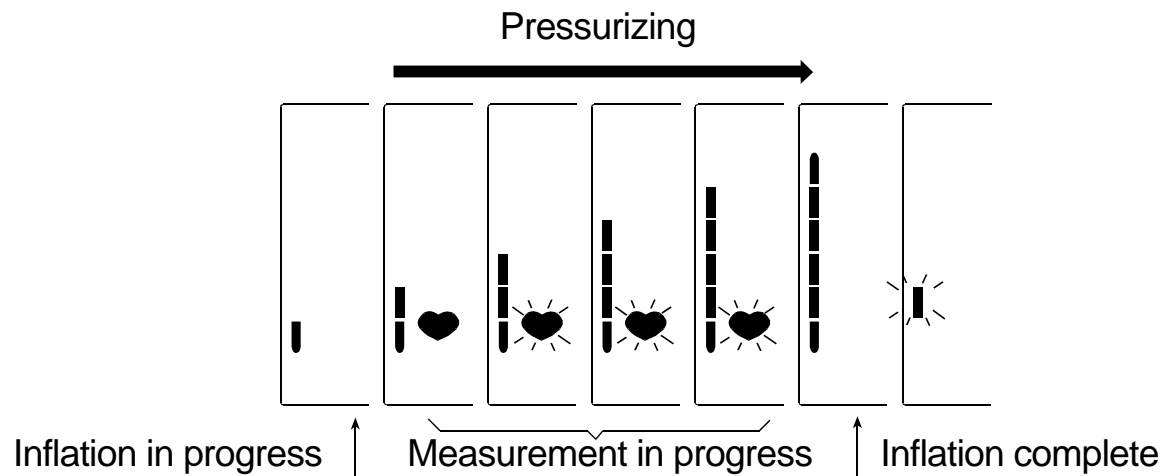

WHO Classification Indicator

Each six segments of the bar indicator correspond to the WHO blood pressure classification described on the next page.

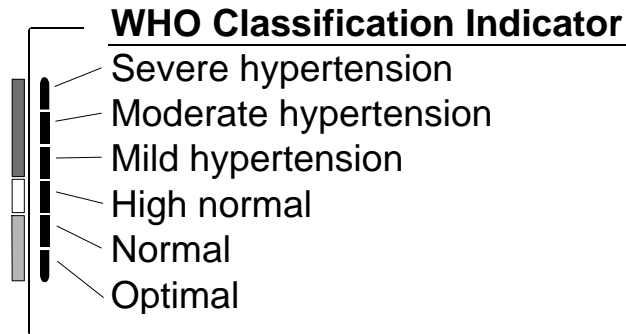

■ : The indicator displays a segment, based on the current data, corresponding to the WHO classification.

Example

Moderate hypertension	Mild hypertension	High normal

About Blood Pressure

What is Blood Pressure?

Blood pressure is the force exerted by blood against the walls of the arteries. Systolic pressure occurs when the heart contracts. Diastolic pressure occurs when the heart expands. Blood pressure is measured in millimeters of mercury (mmHg). One's natural blood pressure is represented by the fundamental pressure, which is measured first thing in the morning while one is still at rest and before eating.

What is Hypertension and How is it Controlled?

Hypertension, an abnormally high arterial blood pressure, if left unattended can cause many health problems including stroke and heart attack. Hypertension can be controlled by altering lifestyle, avoiding stress, and with medication under a doctor's supervision.

To prevent hypertension or keep it under control:

- Do not smoke
- Reduce salt and fat intake
- Maintain proper weight
- Exercise regularly
- Have regular physical checkups

Why Measure Blood Pressure at Home?

Blood pressure measured at a clinic or doctor's office may cause apprehension and can produce an elevated reading, 25 to 30 mmHg higher than that measured at home. Home measurement reduces the effects of outside influences on blood pressure readings, supplements the doctor's readings and provides a more accurate, complete blood pressure history.

WHO Blood Pressure Classification

Standards to assess high blood pressure, without regard to age, have been established by the World Health Organization (WHO), as shown in the chart at the right.

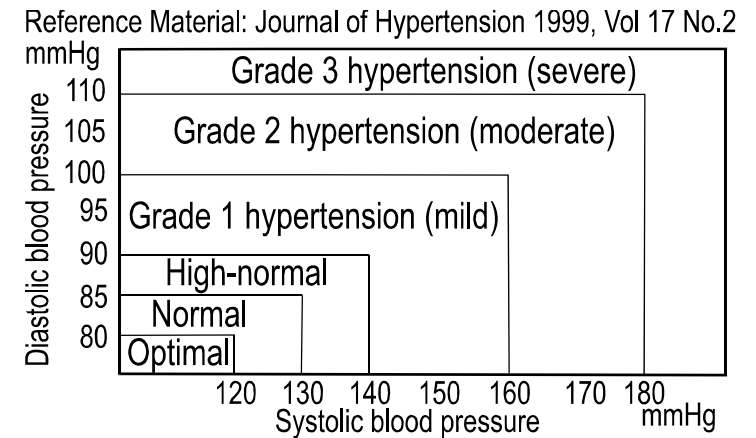

Blood Pressure Variations

An individual's blood pressure varies greatly on a daily and seasonal basis. It may vary by 30 to 50 mmHg due to various conditions during the day. In hypertensive individuals variations are even more pronounced. Normally, the blood pressure rises while at work or play and falls to its lowest levels during sleep. So, do not be overly concerned by the results of one measurement.

Take measurements at the same time every day using the procedure described in this manual to get to know your normal blood pressure. Regular readings give a more comprehensive blood pressure history. Be sure to note the date and time when recording your blood pressure. Consult your doctor to interpret your blood pressure data.

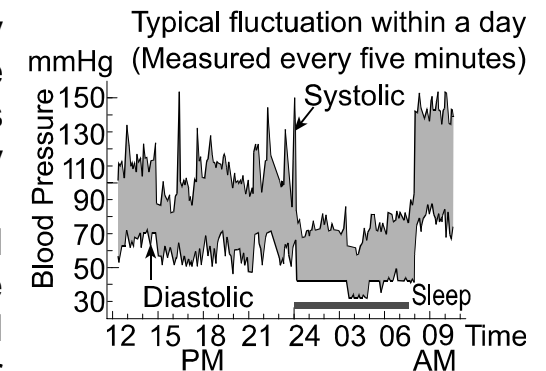

Troubleshooting

Problem	Possible Reason	Recommended Action
Nothing appears in the display, even when the device is turned on.	Batteries are drained.	Replace all batteries with new ones.
	Battery terminals are not in the correct position.	Reinstall the batteries with negative and positive terminals matching those indicated in the battery compartment.
The cuff does not inflate.	Battery voltage is too low.  (LOW BATTERY mark) blinks. If the batteries are drained completely, the mark does not appear.	Replace all batteries with new ones.
The device does not measure. Readings are too high or too low.	The cuff is not applied properly.	Apply the cuff correctly.
	You moved your arm or body during the measurement.	Make sure you remain very still and quiet during the measurement.
	The cuff position is not correct.	Sit comfortably and still. Raise your hand so that the cuff is at the same level as your heart.
	_____	If you have a very weak or irregular heart beat, the device may have difficulty in determining your blood pressure.
Other	The value is different from that measured at a clinic or doctor's office.	See "Why Measure Blood Pressure at Home?".
	_____	Remove the batteries. Place them back properly and try measurement again.



Note: If the actions described above do not solve the problem, contact the dealer. Do not attempt to open or repair this product yourself, as any attempt to do so will make your warranty invalid.

Maintenance

Do not open the device. It uses delicate electrical components and an intricate air unit that could be damaged. If you cannot fix the problem using the troubleshooting instructions, contact the authorized dealer in your area or our customer service department. The A&D customer service will provide technical information, spare parts and units to authorized dealers.

The device was designed and manufactured for a long service life. However it is generally recommended to have the device inspected every 2 years, to ensure proper functioning and accuracy. Please contact the authorized dealer in your area or A&D for maintenance.

Technical Data

Type	UB-542	Clinical test	According to ANSI / AAMI SP-10 1992
Measurement method	Oscillometric measurement	EMC	IEC 60601-1-2: 2007
Measurement range	Pressure: 0 – 299 mmHg Pulse: 40 – 180 beats / minute	Memory	Last 90 measurements
Measurement accuracy	Pressure: ± 3 mmHg Pulse: $\pm 5\%$	Operating condition	+10°C to +40°C / 30%RH to 85 %RH
Power supply	2 x 1.5V alkaline batteries (LR03 or AAA)	Storage condition	-20°C to +60°C / 10%RH to 95 %RH
Wrist circumference	13.5 – 21.5 cm	Dimensions	Approx. 56 [W] x 88 [H] x 18 [D] mm
Classification	Type BF 	Weight	Approx. 103 g, excepting batteries
			 0366

Note: Specifications are subject to change for improvement without prior notice.

EMC table information is listed on our website: http://www.aandd.jp/products/manual/medical/emc_en.pdf



A&D Company, Limited

1-243 Asahi, Kitamoto-shi, Saitama 364-8585 JAPAN
Telephone: [81] (48) 593-1111 Fax: [81] (48) 593-1119



A&D INSTRUMENTS LTD.

Unit 24/26 Blacklands Way, Abingdon Business Park, Abingdon, Oxfordshire OX14 1DY United Kingdom
Telephone: [44] (1235) 550420 Fax: [44] (1235) 550485

A&D ENGINEERING, INC.

1756 Automation Parkway, San Jose, California 95131 U.S.A.
Telephone: [1] (408) 263-5333 Fax: [1] (408)263-0119

A&D Australasia Pty Ltd.

32 Dew Street, Thebarton, South Australia 5031 AUSTRALIA
Telephone: [61] (8) 8301-8100 Fax: [61] (8) 8352-7409

A&D KOREA Limited

한국에이.엔.디(주)

대한민국 서울시 영등포구 여의도동 36-2 맨하탄 B/D 8층
(8th Floor, Manhattan Bldg. 36-2 Yoido-dong, Youngdeungpo-ku, Seoul, KOREA)
전화: [82] (2) 780-4101 팩스: [82] (2) 782-4280